

ZAXIS 650 H

*Designed for
Mining Excellence*



HYDRAULIC EXCAVATOR

Engine Rated Power : 295 kW (400 PS)

Operating Weight : Bachhoe : 58 340 kg
Shovel : 60 500 kg

Bucket
SAE, PCSA Heaped : Bachhoe : 3.3 m³ - 3.8 m³
Shovel : 3.0 m³ - 4.0 m³

Futuristic Performance

High Productivity A Truly high performance machine

- 295 kw (400 ps) powerful engine.
- H/P mode newly used in this model.
- Bucket sizes 3.8 m³ [Standard] / 3.3 m³ [Heavy duty version] Shovel Bucket Sizes of 3.0 m³ / 3.3 m³ / 4.0 m³ available.
- Less fuel consumption during light-load operation from auto acceleration system.

Lower Running Cost Stronger Structural Component Design

- Durable bucket joint
- Reinforced side steps.

Lower Maintenance Cost Reduced Maintenance Time and Expense

- Convenient maintenance doors are provided in the engine cover for quick and easy inspections.
- Auto-grease lubricator and electric grease gun. (Optional)

Rugged Pressurized cab with intergrated headguard:

- Low noise and vibration in cab.
- Boom mode selector helps to control shock and vibration.
- Auto-control air conditioner.





Improved Productivity & Faster Work Completion

Large Displacement Engine Creates Power for High Productivity

- **Engine rated power:**
295 kw (400PS)
- **Engine displacement:**
15.68L

Excavating Power for Tough Job Site

A power engine and efficient hydraulic system team up to boost maximum excavating power. It has the power to take on tough job sites.

- **Bucket :**
306 kN (32 900kgf)
- **Arm :**
250kN (27 600kgf)

Large Bucket Capacity Boosts Productivity

The ZAXIS650H has a bucket capacity that contributes to its productivity. It has been designed to resist wear. The rock bucket has lateral-type wear plates that are easy to replace.

Backhoe Bucket

- 3.8 m³ (G P)
- 3.3 m³ (H D)

Shovel Bucket

- 3.0 m³
- 3.3 m³
- 4.0 m³

Travel Power and speed you can depend on

- **Travel Power :**
415kN (42 300kgf)
- **Travel Speed :**
0 – 5.0 km/h



ZAXIS uses advanced technology to reduce cost while working faster.

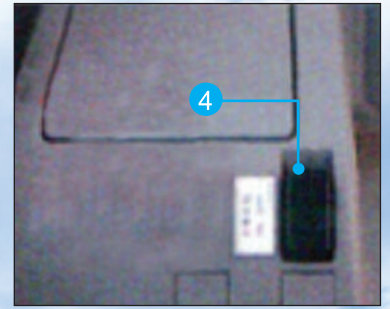
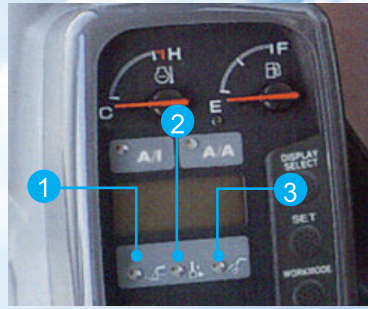

Work Modes for Increased Performance

The four work modes have been enhanced over prior models.

1. General purpose mode
2. Trench digging mode.
3. Attachment mode.
4. Precision mode.



Minimum Effort Maximum Efficiency

The operator's compartment is designed for both comfort and operating efficiency.

FOPS CAB

An ISO-standard FOPS large-size cab is used. It has an integrated overhead guard to help provide protection from falling objects. An optional guard is available for the front wind shield to make the cab OPG level II (ISO) Compliant.

*Fops: Falling Object. Protective Structure
OPG: Operator Protective Guard*



Upper/Lower
cab front guard (Option)

Auto Control Air Conditioner

Simply set the temperature and forget about it . Ducts are positioned to promote even air flow throughout the cab.

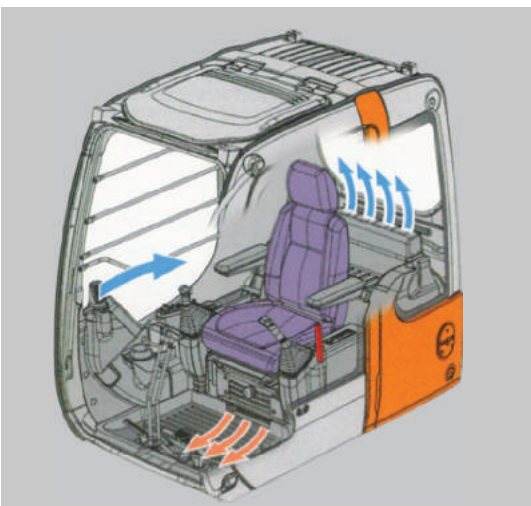

*Illustration shows
a sample of the air flow
during bi-level control.*



One-glance Monitor Panel



Well-positioned Switches

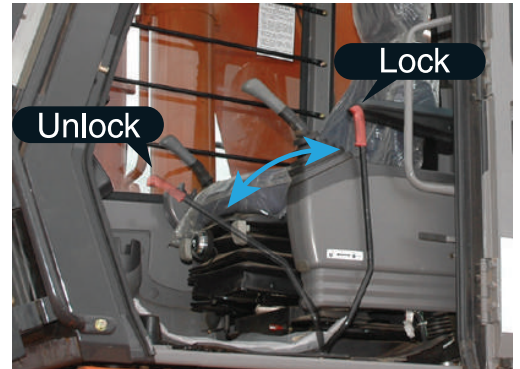

Pilot-Control Shut-off Lever

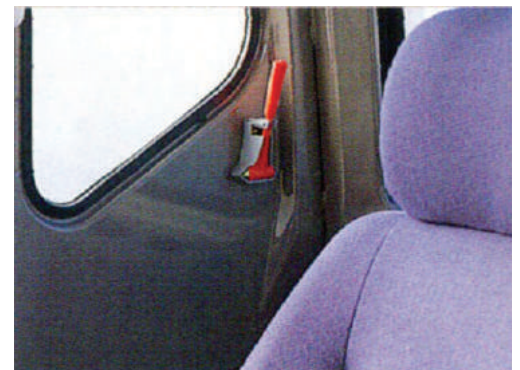

Emergency evacuation hammer

Boom Mode Selector Helps to Reduce Shaking and Jerking of Body During Scraping Operations.

The amount the body can be lifted or pulled by the front of the machine can be **ON** or **OFF** selected. This helps to provide for more comfortable operation and contributes to longer component service life.



ON Comfortable mode



There is little lifting or pulling of the body so there is less vibration and shock.

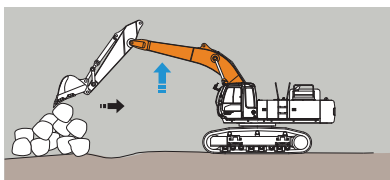

OFF Powerful mode



Much lifting and pulling of the body so there is more vibration and shock.

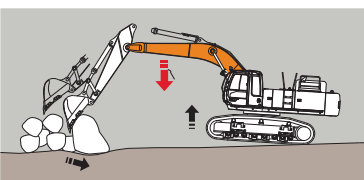

Functional & Durable

Extensive steps have been taken to support basic performance and overall durability.

Durable Bucket Joint

A new design is adopted to bucket joints. Bucket pins are solid and large, and lubricated through bosses for more durability. The use of bucket bushes reduces pin wear.

● Bucket bushings

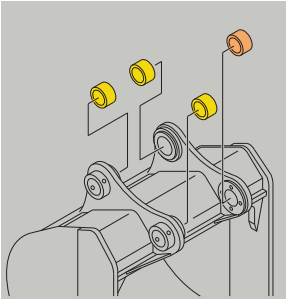

● Boss lubrication to bucket pins

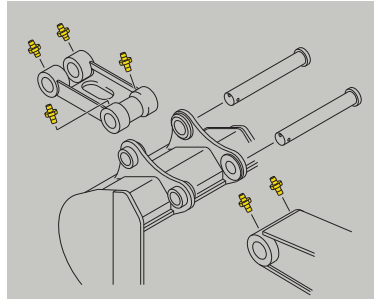

Reinforced Side Steps

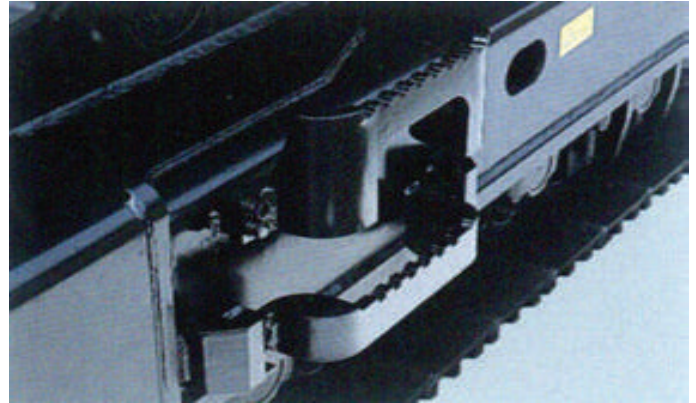

Rugged Undercarriage for Withstanding Tough Jobs

A reshaped box design with X-Beams help disperse stress. This design boosts the overall rigidity of the entire undercarriage.

Travel device Resists Damage

A compact travel device reduces the potential for damage.

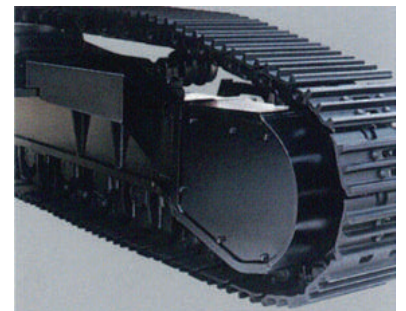

Smart Saving

Advanced technology helps reduce maintenance.

Engine Maintenance Doors

This small maintenance doors are added to the full engine cover. Just open the small maintenance door for easy, quick inspection and maintenance. No need to open the entire cover.



Handy Utility Space



■ Equipment Operation Status Report

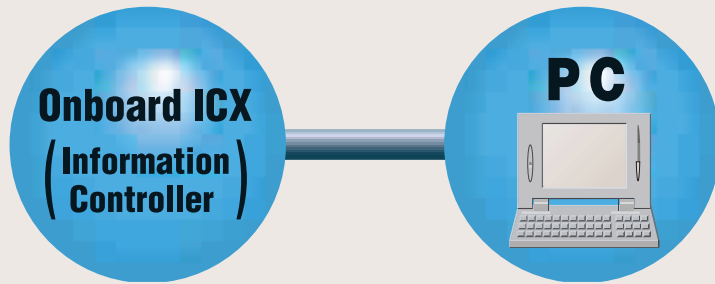

Information
Technology
Support

Information Services for Equipment

- Operation record
- Error record
- Alarm record
- Frequency distribution
Radiator coolant /hydraulic
temperature etc.
and others.

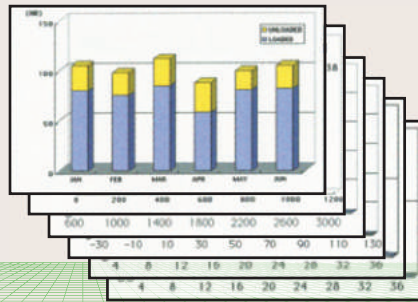

Providing the data for making the right decisions.



Environmentally Friendly Design

Helping ensure a cleaner tomorrow.

Emissions Control Engine

Conforms to U.S. EPA Tier 2 and EC Stage II emission regulations.

Anti Slip pads Reinforced arm dual type track guard bigger bucket

Labeled Plastic Parts Facilitate Efficient Recycling

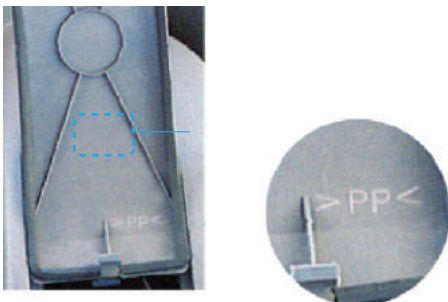

Note: The photo shows a cover opened at time of the inspection. Be sure to close a cover at the time of the operation.

SPECIFICATIONS

ENGINE

Model	Isuzu BB-6WG1X
Type	4-cycle water-cooled, direct injection
Aspiration	Turbocharged
No. of cylinders	6
Rated power	
DIN 6271, net	295 kW (400 PS) at 1 800 min ⁻¹ (rpm)
SAE J1349, net	295 kW (395 HP) at 1 800 min ⁻¹ (rpm)
Maximum torque	1 540 Nm (157 kgf m) at 1 500 min ⁻¹ (rpm)
Piston Displacement	15.681 L
Bore and stroke	147 mm × 154 mm
Batteries	2 × 12 V, 170 AH
Governor	Mechanical speed control by stepping motor

HYDRAULIC SYSTEM

- Work mode selector
 General purpose mode / Trench digging mode
 / Attachment mode
 / Precision mode
 - Engine speed sensing system
- | | |
|------------------------|--|
| Main pumps | 2 variable displacement axial piston pumps |
| Maximum oil flow | 2 × 434 L/min |

Pilot pump	1 gear pump
Maximum oil flow	30 L/min

Hydraulic Motors

Travel	2 axial piston motors with parking brake
Swing	2 axial piston motors

Relief Valve Settings

Implement circuit	30.9 MPa
Swing circuit	29.4 MPa
Travel circuit	34.3 MPa
Pilot circuit	3.9 MPa

Hydraulic Filters

Hydraulic circuits use high-quality hydraulic filters. A suction filter is incorporated in the suction line, and full-flow filters in the return line and swing/ travel motor drain lines.

CONTROLS

Pilot controls. Hitachi's original shockless valve and quick warm-up system built in the pilot circuit. Hydraulic warm-up control system for hydraulic oil.

Implement levers	2
Travel levers with pedals	2

WEIGHTS AND GROUND PRESSURE

Backhoe

Equipped with 6.6 m Boom, 2.9 m Arm and 3.8 m³ (SAE, PCSA heaped) General Purpose Bucket

Shoe type	Shoe width	Operating weight	Ground pressure
Triple grouser	600 mm	58 340 kg	1.04 kgf/cm ²

Shovel

Equipped with Loading Shovel Attachment and 3.5 m³ (SAE, PCSA heaped) Bottom Dump Bucket

Shoe type	Shoe width	Operating weight	Ground pressure
Triple grouser	600 mm	60 500 kg	1.09 kgf/cm ²

UPPERSTRUCTURE

Revolving Frame

Welded, sturdy box construction, using heavy-gauge steel plates for ruggedness. D-section frame for resistance to deformation.

Swing Mechanism

Axial piston motor with planetary gear is bathed in oil. Swing circle is single-row, shear type ball bearing with induction-hardened internal gear. Internal gear and pinion gear are immersed in lubricant. Swing parking brake is spring-set/hydraulic-released disc type. Swing cushion valve built in swing motor absorbs shocks when stopping swing.

Swing speed 7.0 min⁻¹ (rpm)

Operator's Cab

Independent, spacious cab, 1 005 mm wide by 1 820 mm high, conforming to ISO* Standards. Reinforced glass windows on 4 sides for visibility. Openable front windows (upper and lower). Adjustable, reclining seat with armrests; movable with or without control levers and monitor panel.

* International Standard Organisation

UNDERCARRIAGE

Tracks

Tractor-type undercarriage. Welded track frame, using carefully selected materials for tough jobs. Side frame bolted to track frame. Lubricated track rollers, idlers, and sprockets with floating seals. Track shoes with triple grouser made of induction-hardened rolled alloy. Heat-treated connecting pins with dirt seals. Hydraulic (grease) tra3.83.8ck adjusters with shock-absorbing recoil springs.

Upper rollers	3
Lower rollers	8
Track shoes	48
Track guard	2
H-track center guard (dual type)	1
Ground Pressure.....	1.04kgf/cm ²

Traction Device

Each track driven by axial piston motor through reduction gears for counter-rotation of the tracks. Sprockets are replaceable. Parking brake is spring-set/hydraulic-released disc type. Travel shockless relief valve built in travel motor absorbs shocks when stopping travel, ensuring smooth stops.

Travel speeds	High: 0 to 5.0 km/h Low: 0 to 3.5 km/h
Maximum traction force	415kN (42 300 kgf)
Gradeability	35° (70%) continuous

SERVICE REFILL CAPACITIES

	liters
Fuel tank	740
Engine coolant	98
Engine oil	55
Pump drive	7
Swing mechanism (each side)	10.5
Travel final device (each side)	14
Hydraulic system	618
Hydraulic tank	310

SPECIFICATIONS



BACKHOE ATTACHMENT

Boom and arms of all-welded, box-section design. Bucket is all welded, high-strength steel structure. Side clearance adjust mechanism provided on the bucket joint bracket.



WORKING RANGES

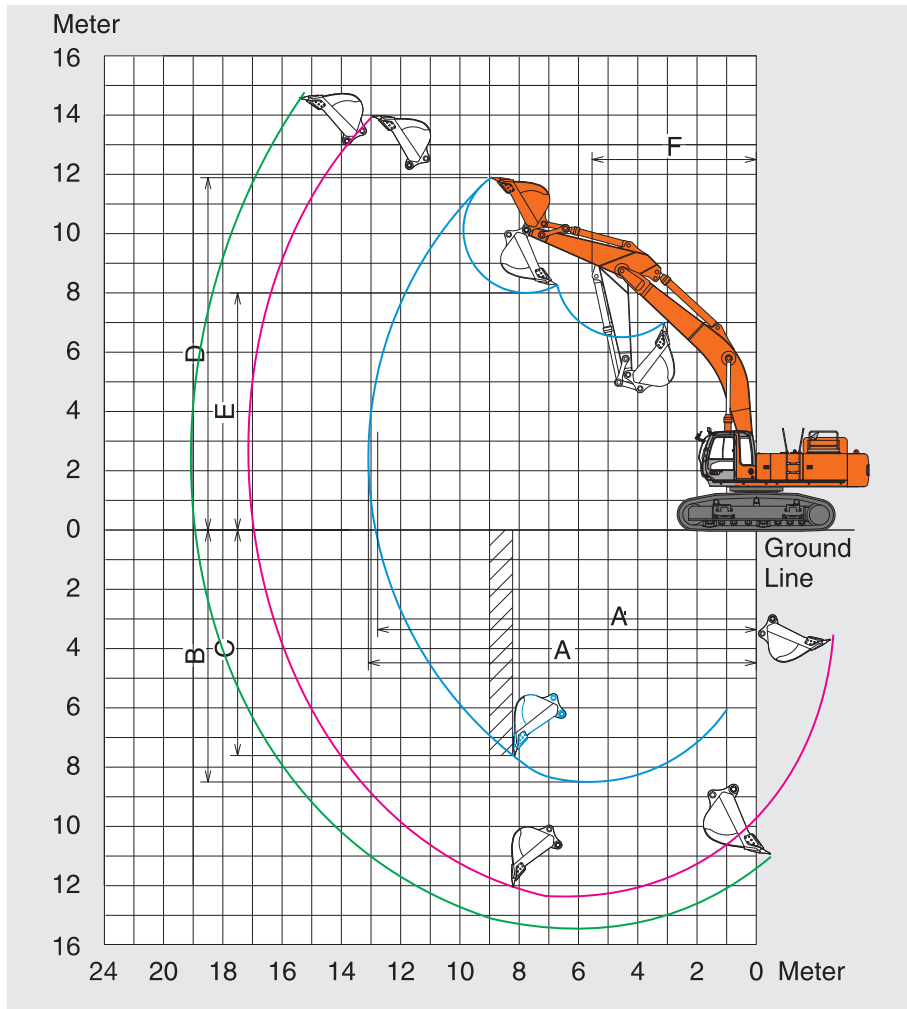

Figure not to scale

Unit : mm

	Boom Length	6 600	9 200	9 200
	Arm Length	2 900	7 000	9 000
A	Max. Digging Reach	11 540	17 368	19 636
A'	Max. Digging Reach on Ground	11 350	17 189	19 477
B	Max. Digging Depth	7 080	12 636	15 208
C	Max. Vertical Wall Depth	5 140	9 790	6 500
D	Max. Cutting Height	10 770	13 738	14 517
E	Max. Dumping Height	6 980	10 802	11 101
F	Min. Swing Radius	4 930	6 600	6 820
	Bucket Digging Force* ISO	308 kN (31400 Kgf)	280 kN (28600 Kgf)	250 kN (25500 Kgf)
	Arm Crowding Force* ISO	258 kN (26300 Kgf)	137 kN (14000 Kgf)	110 kN (11200 Kgf)
	Power Boost Arm Crowding Force* ISO	322 kN (32900 Kgf)	294 kN (30000 Kgf)	263 kN (26800 Kgf)
	Power Boost Arm Crowding Force* ISO	270 kN (27600 Kgf)	143 kN (14600 Kgf)	116 kN (11800 Kgf)

SPECIFICATIONS

Backhoe Buckets

Capacity	Width		No. of Teeth	Weight	Boom 6.6 m Arm 2.9 m
	Without Side Cutters	With Side Cutters			
3.8 m ³	1 850 mm	1 990 mm	5	3 020 kg	●
3.3 m ³	1 690 mm	1 744 mm	5	2 980 kg	○

Backhoe Buckets

Capacity	Width		No. of Teeth	Weight	Boom 9.2 m	
	Without Side Cutters	With Side Cutters			Arm 7.0 m	Arm 9.0 m
1.0 m ³	860	NA	5	1 127 kg	○	●
1.6 m ³	1 190	NA	5	1 523 kg	●	○

● Suitable for materials with density of 1 800 kg/m³

○ Heavy-duty service

○ Not Suitable

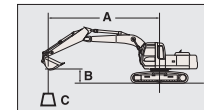

A: Load radius
B: Load point height
C: Lifting capacity

Lifting Capacities

Unit: 1 000 kg

Conditions	Load point height	Load radius										At max. reach				
		4 m		5 m		6 m		7 m		8 m		9 m		meter		
Boom 6.6 m	7 m									*9.6	*9.6			*6.1	*6.1	10.1
	6 m							*10.2	*10.2	*9.7	*9.7			*6.1	*6.1	10.5
Arm 2.9 m	4 m					*13.9	*13.9	*12.0	*12.0	*10.8	*10.8	8.9	*9.9	6.1	*6.4	10.9
	2 m					*14.9	*14.9	*12.9	*12.9	11.1	*11.5	8.9	*10.7	6.1	*6.8	10.9
Bucket 3.8 m ³	0 (Ground)					16.7	*17.2	13.1	*14.1	10.4	*12.1	8.5	*10.7	5.9	*7.0	10.5
	-2 m					16.7	*18.4	13.1	*15.1	10.4	*13.0	8.5	*11.5	5.9	*7.4	10.5
Shoes 600 mm	-2 m	*25.0	*25.0	21.4	*21.7	15.6	*18.0	12.1	*15.1	9.7	*12.7	8.1	*10.6	7.6	*8.8	9.5
	-4 m	*26.4	*26.4	21.4	*23.1	15.6	*19.3	12.1	*16.2	9.7	13.6	8.1	11.3	7.6	*9.5	
	-5 m	*20.5	*20.5	*17.8	*17.8	*15.0	*15.0	12.4	*12.5							
	-5 m	*21.9	*21.9	*19.0	*19.0	15.9	*16.1	12.5	*13.4							
	-5 m	*16.4	*16.4	*14.4	*14.4	*12.1	*12.1									
		*17.7	*17.7	*15.5	*15.5	*13.0	*13.0									

Unit: 1 000 kg

Conditions	Load point height	Load radius										At max. reach				
		4 m		6 m		8 m		10 m		12 m		14 m		meter		
Boom 9.2 m	6 m									*3.3	*3.3	*2.3	*2.3			
	4 m							*3.8	*3.8	*3.1	*3.1	2.4	*2.6			
Arm 7.0 m	2 m					*8.5	*8.5	*6.5	*6.5	*4.7	*4.7	*3.5	*3.5	2.0	2.8	
	0 (Ground)	*22.8	*22.8	11.9	*12.4	7.2	*7.9	4.6	*5.5	2.8	3.9	1.6	2.5			
Bucket 1.6 m ³	-2 m	22.0	*23.7	10.2	13.2	6.1	7.7	3.8	5.1	2.4	3.4	1.4	2.2			
	-4 m	21.5	*23.0	9.51	2.5	5.4	7.2	3.4	4.7	2.1	3.1	1.2	2.0			
Shoes 600 mm	-6 m	*21.2	*21.2	9.51	2.4	5.3	7.1	3.2	4.5	2.0	3.0					
	-8 m	*17.9	*17.9	9.91	*1.5	5.5	7.3	3.4	4.7							
	-10 m	*12.71	*2.7	*8.4	*8.4	*5.5	*5.5									

* Load Height at max reach=2.4 m;
Load Radius at max reach=15.7 m

Notes: 1. Ratings are based on SAE J1097.

2. Lifting capacity of the ZAXIS Series does not exceed 75% of tipping load with the machine on firm, level ground or 87% full hydraulic capacity.

3. The load point is a hook (not standard equipment) located on the back of the bucket.

4. *Indicates load limited by hydraulic capacity.

5. Figures in shaded area are with heavy-lifting system.

6. Loads mentioned in 1000 kg

SPECIFICATIONS

LOADER ATTACHMENT

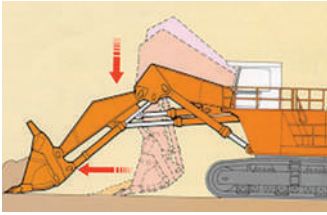

Auto-Leveling Crowd Mechanism

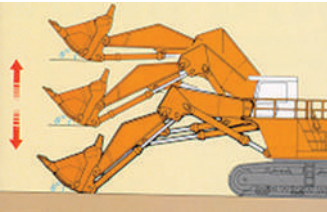

Auto Bucket level raise system

Patented Auto Level Crowd Mechanism

TATA Hitachi's unique patented auto level crowd mechanism on the ZX650H shovel version gives exceptional job efficiency, loading capability and operating ease. The level crowding operations are greatly simplified with just one control lever needed, the result is dramatically shorter cycle time and greatly increased productivity. This design also enables the crowd force to become strongest around the maximum reach point where the force is most required.

The parallel link mechanism keeps the bucket digging angle constant, and level cylinder circuit maintains the bucket height constant. Due to this feature the need for additional clean-up equipment is also eliminated as it ensures a level mine floor contributing to increased tyre life of the haul equipment. It also facilitates Auto-Bucket level raise avoiding spillage of the material apart from contributing greatly to the increased productivity. Patents registered in USA, Germany and Japan.

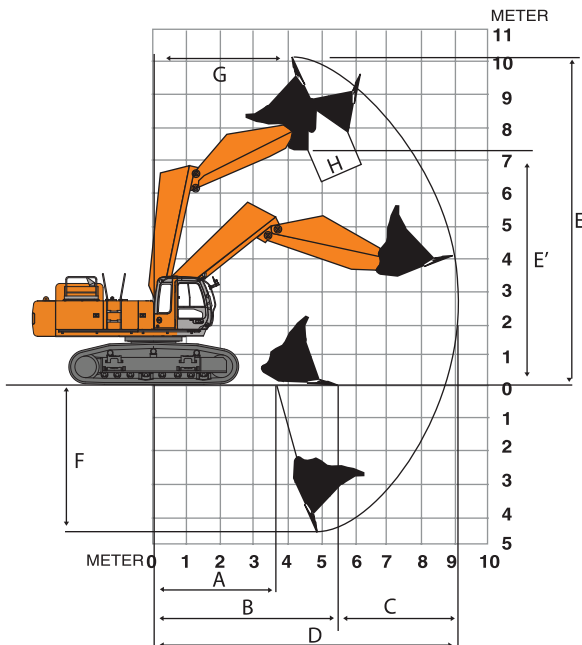

Working Ranges

	Boom Length	4 300
	Arm Length	3 300
A	min. Digging reach	3 794
B	min. Level crowding distance	5 487
C	Level crowding distance	3 302
D	max. Digging reach	9 216
E	max. Cutting height	10 147
E'	max. Dumping height	7 388
F	max. Digging depth	4 602
G	Working Radius at max. Dumping Height	4 768
H	max. Bucket Opening Width	1 420

All dimension are in mm

Arm Crowding Force (kgf)*	38 140
Bucket Breakout Force (kgf)*	38 600

* As per ISO standards.

Shovel Buckets

Type	Bottom Dump	Bottom Dump	Bottom Dump
Capacity	3.0 m ³	3.3 m ³	4.0 m ³
Width	1832 mm	1910 mm	2160 mm
Weight	4840 kg	4880 kg	4953 kg
No. of tooth points	6	6	6

DIMENSIONS

Unit: mm

A	Distance between tumblers	4 250
B	Undercarriage length	5 330
C	Counterweight clearance	1 450
D	Rear-end swing radius	3 800
E	Rear-end length	3 800
F	Overall width of upperstructure	3 310
G	Overall height of cab	3 500
H	Min. ground clearance	810
I	Track gauge	3 200
J	Track shoe width	600
K	Undercarriage width	3 800
L	Overall length	13 030
M	Overall width	3 990
N	Overall height of boom	4 270

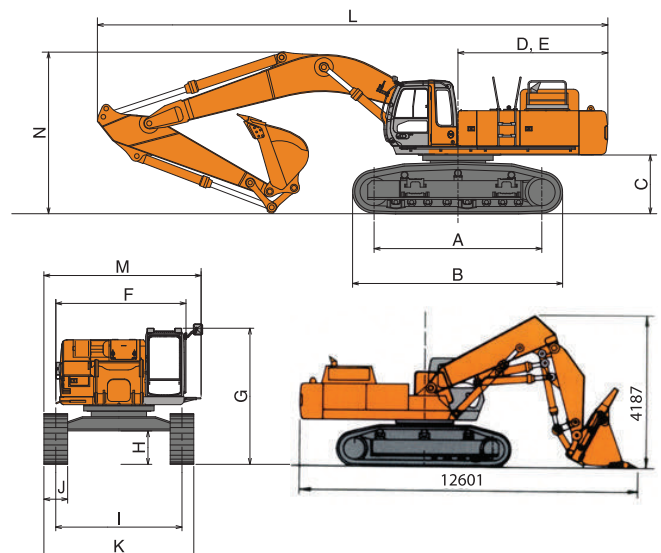

SPECIFICATIONS

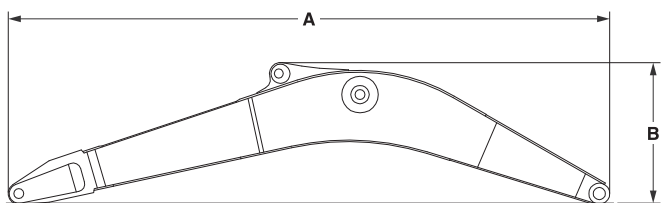

Backhoe Boom

	A	B	Overall width	Weight
6.6 m	6 880 mm	2 320 mm	1 180 mm	5 250 kg

Backhoe Long Boom

	A	B	Overall width	Weight
9.2 m	9 490 mm	2 150 mm	1 185 mm	5 300 kg

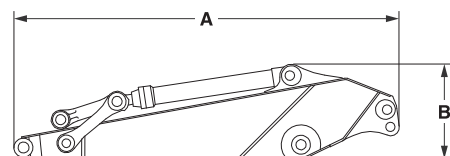

Backhoe Arm

	A	B	Overall width	Weight
2.9 m	4 290 mm	1 440 mm	790 mm	3 210 kg

Backhoe Long Arm

	A	B	Overall width	Weight
9.0 m	10 385 mm	1 270 mm	700 mm	4 391 kg
7.0 m	8 380 mm	1 340 mm	700 mm	3 965 kg

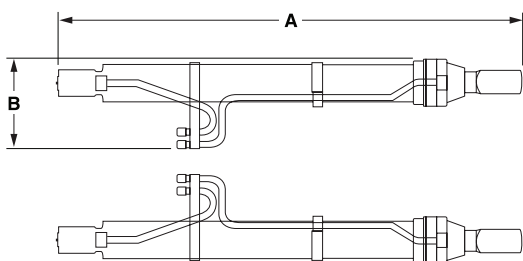

Boom cylinders

520 kg × 2

A	B	Overall height
2 660 mm	520 mm	360 mm

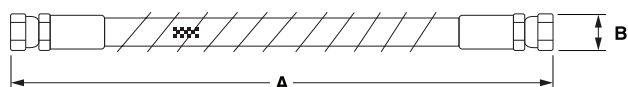

Hose of boom cylinders

6 kg × 4

A	B
1 120 mm	41 mm

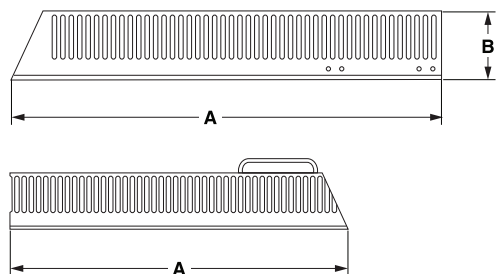

Left sidewalk

	A	B	Overall width	Weight
Front	1 920 mm	430 mm	130 mm	40 kg
Reverse	2 410 mm	340 mm	130 mm	40 kg

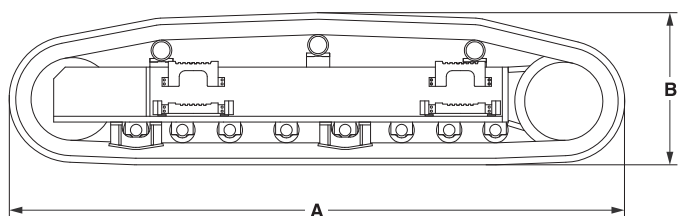

Side frame

	Shoe width	A	B	Overall width	Weight
ZAXIS650H	600 mm	5 330 mm	1 310 mm	720 mm	7 900 kg

SPECIFICATIONS

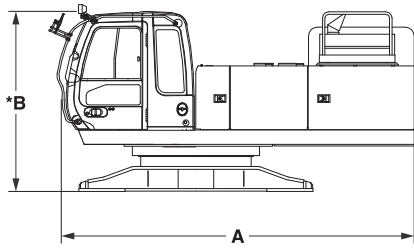

Upperstructure

	A	B	Overall width	Weight
ZAXIS650H	5 000 mm	2 650 mm	3 290 mm	18 600 kg

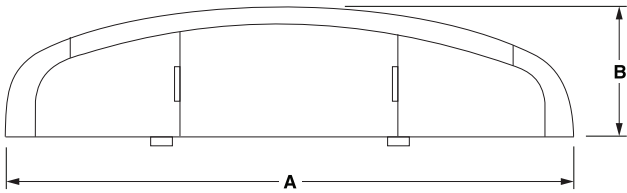

Counterweight

A	B	Overall height	Weight
3 210 mm	790 mm	1 250 mm	10 500 kg

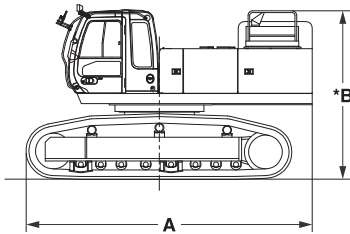

Basic machine (without counterweight)

	Shoe width	A	B	Overall width	Weight
ZAXIS650H	600 mm	5 730 mm	3 500 mm	3 300 mm	34 300 kg

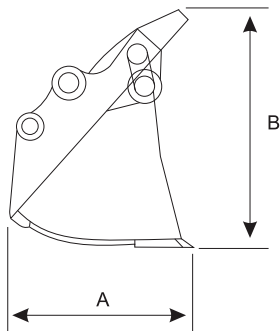

Shovel Bucket

A	B	Overall width	Weight
1 616 mm	2 090 mm	2 010 mm	4 724 kg

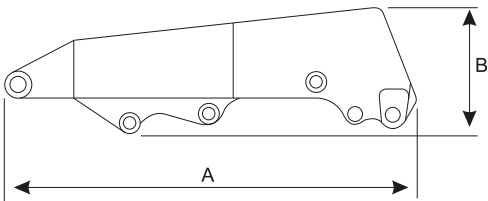

Shovel Boom

A	B	Overall width	Weight
4 710 mm	1 441 mm	1 218 mm	3 461 kg

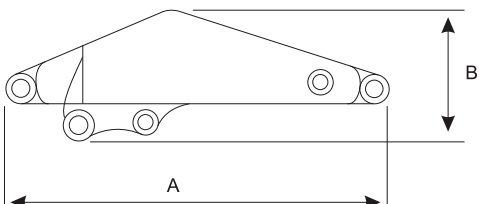

Shovel Arm

A	B	Overall width	Weight
3 579 mm	1 222 mm	966 mm	2 123 kg

EQUIPMENT

ENGINE	
Air cleaner double filters	●
Auto idle system	●
Cartridge-type engine oil filter	●
Cartridge-type fuel pre-filter	●
Cartridge-type fuel main filter	●
Dry-type air filter with evacuator valve (with air filter restriction indicator)	●
ECO/PWR mode control	●
Fan guard	●
Water separator	●
Pre-cleaner	○
Dust-Proof indoor net	●
Radiator reserve tank	●
50 A alternator	●

HYDRAULIC SYSTEM	
Control valve with main relief valve	●
Full-flow filter	●
Pilot filter	●
Power boost	●
Suction filter	●
One extra port for control valve	●
Work mode selector	●

CAB	
All-weather sound suppressed steel cab	●
AM-FM radio with 2 speakers	●
Ashtray	●
Auto control air conditioner	●
AUX. terminal and storage	○
H-Cab	●
Drink holder	●
Drink holder with hot & cool	●
Electric double horn	●
Engine shut-off lever	●
Evacuation hammer	●
Floor mat	●
Footrest	●
Front window washer	●
Front windows on upper, lower and left side can be opened	●
Lower cab front guard	○
Upper cab front guard	○
Glove compartment	●
Hot & cool box	●
Intermittent windshield wipers	●

Key cylinder light	●
OPG top guard Level I (ISO10262) compliant cab	●
Pilot control shut-off lever	●
Rear tray	●
Retractable seat belt	●
Rubber radio antenna	●
Seat : fabric seat	●
Seat : mechanical suspension seat	●
Seat : air suspension seat with heater	○
Seat adjustment part : backrest, armrest, height and angle, slide forward / back	○
Short wrist control levers	●
Twin wiper	●
4 fluid-filled elastic mounts	●
24V cigarette lighter	●

MONITOR SYSTEM	
Alarm buzzers: overheat, engine oil pressure, overload	●
Alarms: overheat, engine warning, engine oil pressure, alternator, minimum fuel level, hydraulic filter restriction, air filter restriction, work mode, overload, etc	●
Display of meters: water temperature, hour, fuel rate, clock	●
Other displays: work mode, auto-idle, glow, rearview monitor, operating conditions, etc	●
32 languages selection	●

LIGHTS	
Additional cab roof front lights	○
Additional boom light with cover	○
2 working lights	●

UPPER STRUCTURE	
Electric fuel refilling pump	○
Fuel level float	●
Hydraulic oil level gauge	●
Rear view camera	○
Rear view mirror (right & left side)	●
Swing parking brake	●
Tool box	●
Undercover	●
6.0 mm reinforced undercover	○
Utility space	●
6 350 kg counterweight	●

UNDERCARRIAGE	
Bolt-on sprocket	●
Reinforced track links with pin seals	●
Travel parking brake	●
9.0 mm reinforced track undercover	○
Track guard (each side) and hydraulic track adjuster	●
Upper and lower rollers	●
3 track guards	●
4 tie down hooks	●
600 mm triple grouser shoes	●

FRONT ATTACHMENTS	
Casted bucket link A	●
Dirt seal on all bucket pins	●
Flanged pin	●

ATTACHMENTS	
Attachment basic piping	○
Breaker and crusher piping	○
High mesh full flow filter with restriction indicator	○
Parts for breaker and crusher	○
2 pump combined flow for attachment basic piping	○
Line filter	○

MISCELLANEOUS	
Lockable fuel refilling cap	●
Lockable machine covers	●
Onboard information controller	●
Skid-resistant tapes, plates and handrails	●
Standard tool kit	●
Travel direction mark on track frame	●

- Standard
- Optional

These specifications are subject to change without notice.

Illustrations and photos show the standard models, and may or may not include optional equipment, accessories, and all standard equipment with some differences in color and features.

Before use, read and understand the Operator's Manual for proper operation.

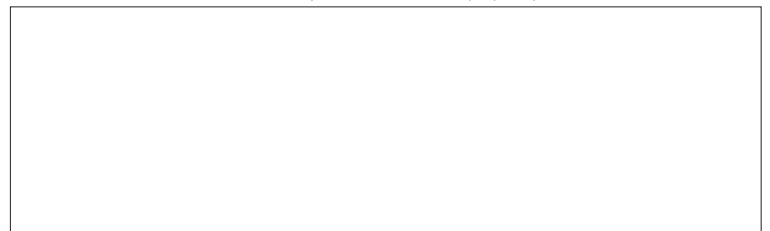

Tata Hitachi Construction Machinery Company Private Limited

(Formerly non as Tata Hitachi Construction Machinery Company Limited)

Registered Office: Jubilee Building 45 Museum Road Bangalore 560 025 India

Telephone: +91 80 66953301 02 03 04 05 Fax: +91 80 6695 3309 2532 5792

Email: info@tatahitachi.co.in Website: www.tatahitachi.co.in

Toll Free: 1800 121 6633